

# radiustrack®

Radius Track develops and fabricates framing systems for domes of all shapes and sizes.



## DOMESOLUTIONS

Cold-formed steel framing systems for interior and exterior domes.



# Exterior & interior dome solutions

## Simplified framing for a complex shape

**BASIC DOME SOLUTION** Radius Track Dome Solutions include pre-shaped structural components ready for assembly.

Typical Components Include:

- Compression ring
- Ribs
- Angle clips
- Tension ring or base ring
- Rib cross-bracing
- Pre-cut plywood sheathing (optional)

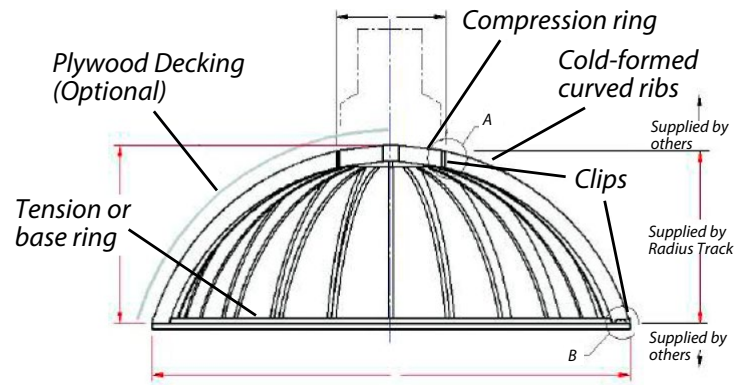

### Above the Dome

Radius Track will coordinate engineering required for a cupola, finial, oculus or other design elements at the top of the dome.

The dome framing system accommodates specific mounting needs and skylight openings specified in construction documents.

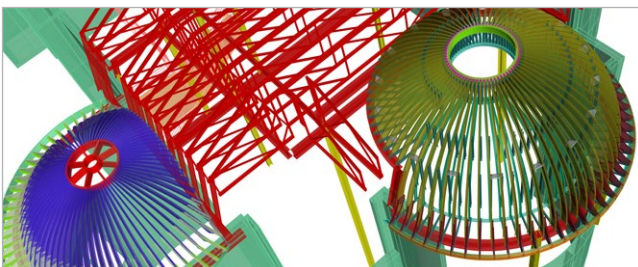
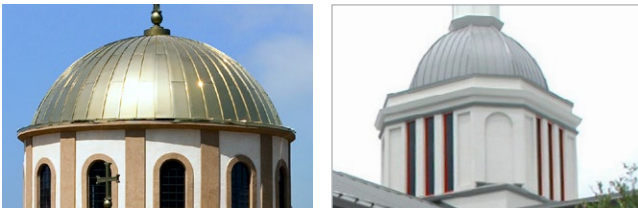

### Below the Dome

Domes may be affixed to different mounting surfaces. Typical mounting surfaces include:

- Continuous rolled beam or tube (recommended method)
- Minimum 3 inches of 3000 psi concrete
- Minimum 18-gauge steel decking

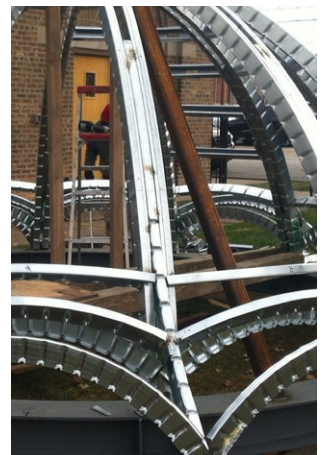



# Solutions for large & complex domes

Lightweight design saves up to 30% material + labor

## Box Beam Truss Solutions

Dome ribs made from light-gauge box-beams or box-beam trusses by Radius Track may be used to top large spaces with or without coffers. Constructing large domes using a cold-formed steel box-beam method provides lightweight component installation and structural performance.



PHOTO CREDIT: IWAN BAAH

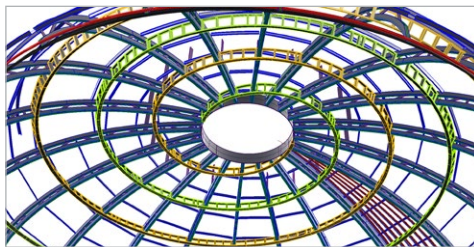

## Infill (Hybrid) Solutions

Domes larger than 45'- 0" in diameter may be constructed using a combination of Radius Track light-gauge dome ribs as infill framing with heavier structural steel members. Hybrid domes have the ability to reduce material and labor costs by 30%.

**COLD-FORMED STEEL DOMES:**  
lightweight, cost-effective  
and constructable

Reduced handling time  
Faster installation time  
Framer/Carpenter installed  
Easy sheathing attachment

## ADVANTAGES of bringing Radius Track Corporation into the process early:

### 1. TIMELINE

Radius Track project management ensures the dome is delivered to the project site ready for assembly when you need it.

### 2. COSTS

The dome will be made to project specification with lightgauge framing elements configured cost effectively.

### 3. SHEATHING

If pre-cut contoured plywood sheathing is required, it will be delivered with the dome framing elements for immediate dry-in.

### 4. EXPERTISE

Our team collaborates with you from contract start to close out.

## TYPICAL DOME SHAPES



*12-Sided Dome*



*Standard Exterior Dome*

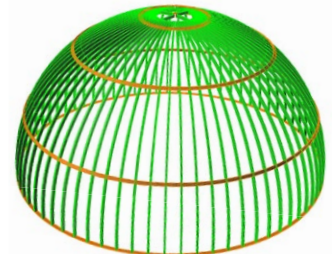

*Large Interior Dome*



*Exterior Elliptical Dome*

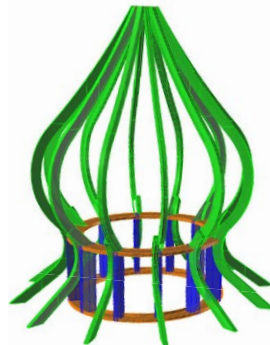

*Onion Dome*

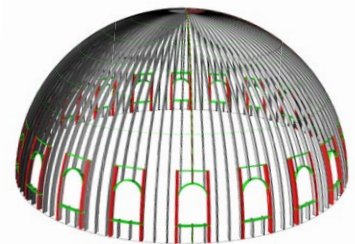

*Large Dome with Windows*

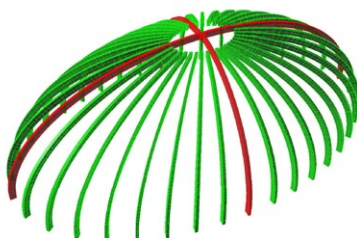

*Interior Elliptical Dome*

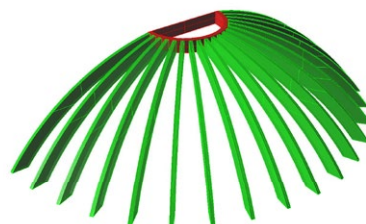

*Large 1/2 Dome*

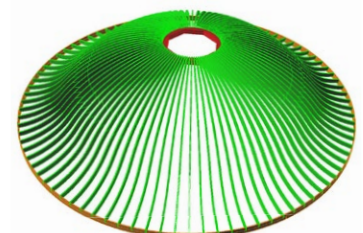

*Bell Shaped Dome*



# Exterior & interior dome projects

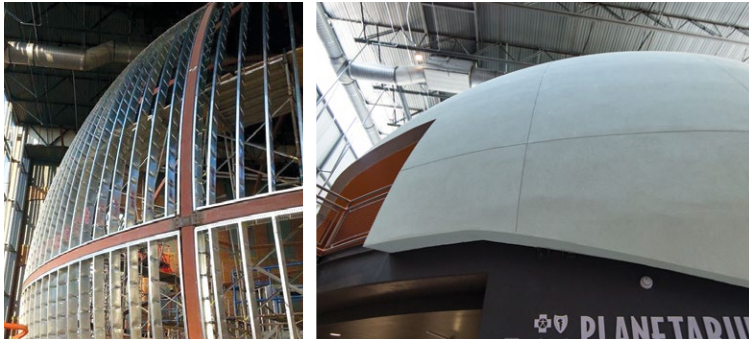

South Carolina State Museum (SCSM) Planetarium, Columbia, SC



St. Andrew Orthodox Christian Church, Riverside, CA



The Greek Orthodox Church of the Resurrection, Glen Head, NY

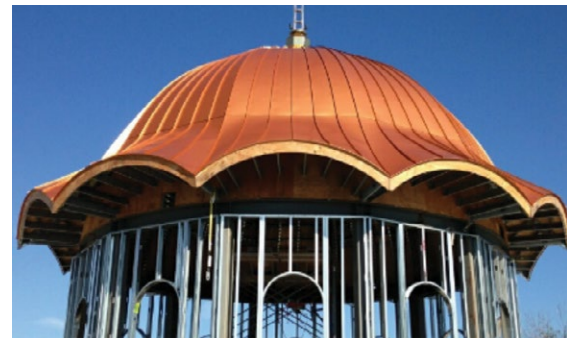

Turkish American Community Center, Lanham, MD



Private Residence, Hudson Valley, NY

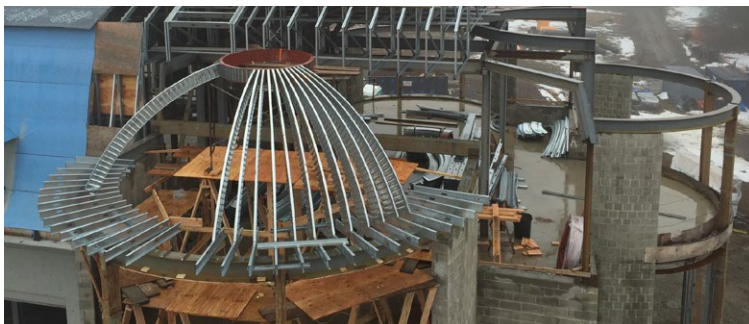

Holy Nativity Romanian Orthodox Church, Chicago, IL